

# ***SBC8018 Evaluation Board***

Integrated with SATA, TF, OTG, Audio in/out, USB, Ethernet, LCD, CCD/COMS, Serial, JTAG  
interface based on 32-bit microcontroller

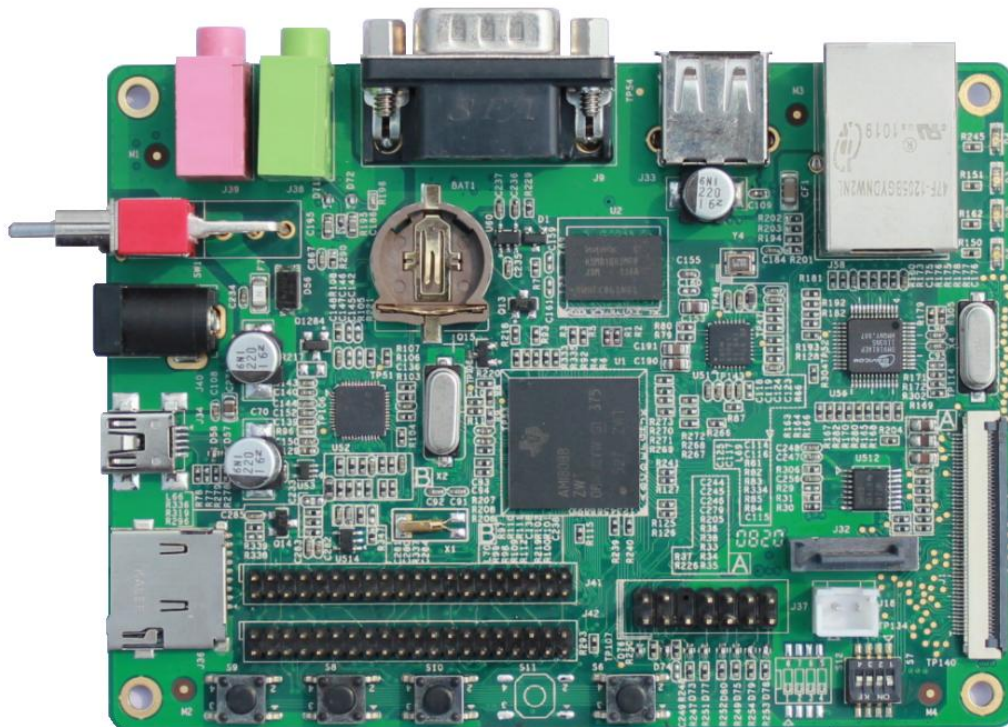

## ***Quick Operation Manual***

**Version update records:**

Version	Date	Description
1.0	2011.12.21	Original version

# Contents

Chapter 1 Overview.....	4
1.1 Getting Started Quickly .....	5
1.2 Development Kit Content .....	6
Chapter 2 Quick Setup of Development Environment.....	8
2.1 Hardware Setup .....	8
2.2 Software Setup.....	9
2.2.1 Windows XP Setup .....	9
2.2.2 Notes for operating system image file .....	13
Chapter 3 Hands-on and Quick use of Operating System .....	14
3.1 Quick Start up with Linux system.....	14
3.1.1 Boot-up from Serial port .....	14
3.1.2 Update images from Ethernet.....	15
3.2 Quick Start up with WinCE system .....	19
3.2.1 Flashing EBOOT to NAND Flash .....	19
3.2.2 How to update TF Card NK runtime images .....	21
Customer Service & Technical support .....	29
Customer Service.....	29
Technical Support.....	29
Notes .....	29

# Chapter 1 Overview

The primary purpose of this document is to quickly understand the hardware and software development environment for SBC8018 evaluation board, and help the user to get into the product development faster;

**1) This Document mainly has the following sections:**

- a) How to use documents and CD information quickly
- b) Evaluation board hardware components and suite configuration
- c) Evaluation board hardware and software default configurations
- d) Quick setup of the development environment
- e) Hands-on and quick use of Linux/WinCE operating systems

**2) Factory default configuration of SBC8018 evaluation board**

- a) Hardware Configuration: no RTC cell (Cell: CR1220)
- b) Software factory default parameters
  - SBC8018 evaluation board preferably boots from serial port, NAND Flash, and support update image via TF card, net port
  - NAND Flash is installed (by default) with **linux2.6.33** operating system and 4.3-inch screen driver

**3) List of option add-on modules for SBC8018 evaluation board:**

Modules	Linux	WinCE	Notes
WF8000-U	NO	YES#	Provided with CD-ROM Separately
CAM8000-A	YES*	YES*	Provided with CD-ROM on Development board
CDMA8000-U	NO	YES#	<a href="#">Download here</a>
WCDMA8000-U	NO	YES#	<a href="#">Download here</a>

Table 1-1

\* = Provided with Source Code    # = Not Provided with Source Code

## 1.1 Getting Started Quickly

In this section user will learn how to understand and use SBC8018 evaluation board efficiently and faster using SBC8018 evaluation board Quick User Manual. For more information please refer to the document and location listed below:

### For Hardware Development:

Hardware system	Introduce CPU, expanded chip and hardware interface	User Manual->Chapter 2 Hardware System
CPU Datasheet	Know principle and configuration	CD->\HW design\datasheet\CPU\
Schematic diagram	Know hardware principle	CD->\HW design\schematic
Dimensional drawing	Refer to the actual dimension to bring convenience for opening die	User Manual->Appendix->Appendix I Hardware Dimensions

Table 1-2

### For Software Development:

Establish testing environment	To connect with external hardware devices, set serial port terminals and boots the system	Quick Operation Manual->2 Quick establishment of development environment 3 Handover and quick use of operating system
Test functionality of interface	Test the interface of the board carrier through the operating system	User Manual ->3.6.1 Various Tests scenario
Establish developing and compilation environment	Linux developing and compilation environment	User Manual -> 3.4.1 Establishing operating system development environment
	WinCE developing and compilation environment	User Manual->4.4.1 Installation of IDE 4.4.2 Extract BSP and project files to IDE
Recompile system image	Recompile Linux system image	User Manual->3.4.2 System Compilation
	Recompile WinCE system image	User Manual->4.4.3 Sysgen & Build BSP

Software development	Refer to introduction of Linux application development process	User Manual->3.7 The Development Of Application
	Refer to introduction of WinCE driver and related driver development process	User Manual -> 4.4.4 Source code path of all drivers in BSP:

Table 1-3

**For Marketing:**

Hardware system	CPU feature, board carrier interface data	User Manual->Chapter 2 Hardware System
About Linux / WinCE software	Know basic Linux software components and features, and purpose of compilation tool	User Manual->3.2 Software Resources 3.3 Software Features
	Know basic WinCE software components and features, and purpose of compilation tool	User Manual->4.2 Software Resources 4.3 Software Features
Dimensional drawing	Refer to the actual dimension to bring convenience for opening die	User Manual->Appendix-> Appendix I Hardware Dimensions

Table 1-4

**For Personal Learning Purpose:**

It is suggested to browse all the sections in each chapter of this Manual..

## 1.2 Development Kit Content

SBC8018 evaluation board is available in two bundles; Standard and Full bundle, the kit contents for each bundle is given below:

**Standard Bundle**

- SBC8018 evaluation board
- Serial port line (DB9-DB9)
- 5V@2A power adapter

**Full Bundle**

- Standard configuration of SBC8018 evaluation suite
- 4.3-inch LCD display screen or 7-inch display screen (with touch screen)

**DVD/CD Contains:**

- SBC8018 Quick Operation Manual
- SBC8018 User Manual
- Schematic Diagram, Board Carrier Chip Datasheet
- Development Kit Software (Linux/WinCE)

# Chapter 2 Quick Setup of Development Environment

## 2.1 Hardware Setup

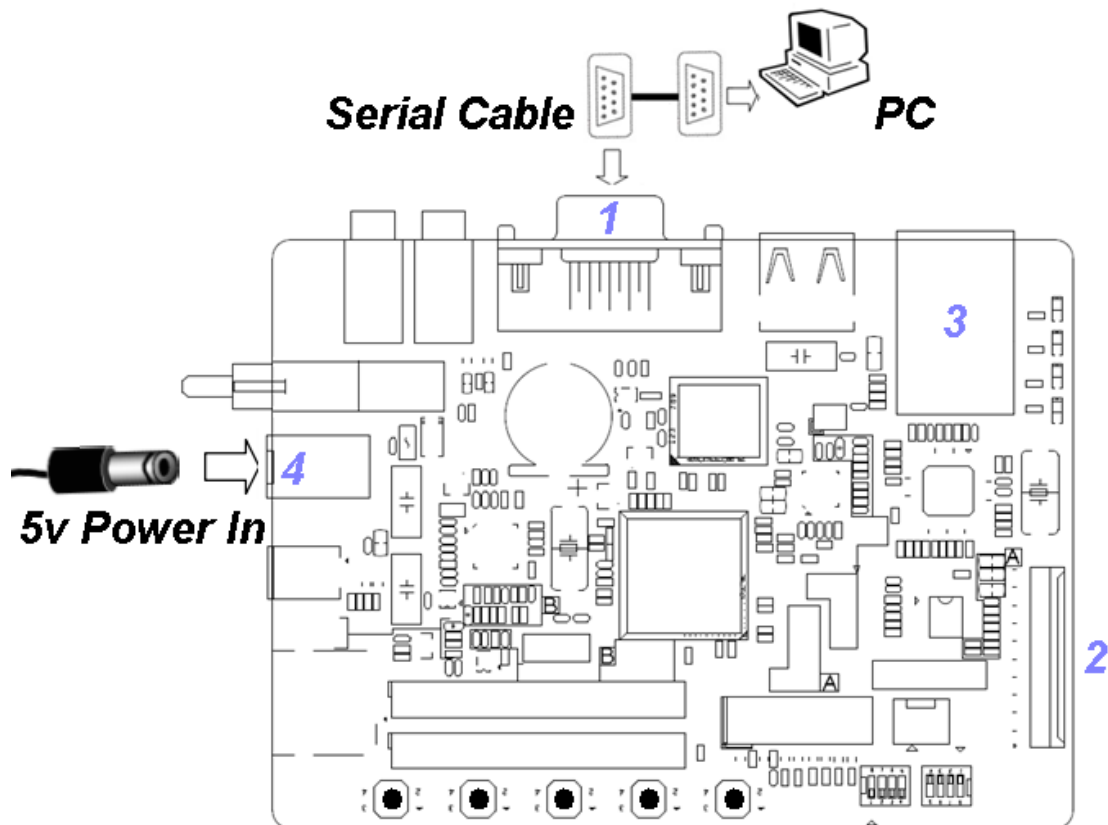

Figure 2-1

Please follow the below steps for hardware setup:

**1) Connect serial port for communication**

Use serial cable to connect the debugger serial port, PC serial port and SBC8018 serial port.

**2) Connect TFT-LCD**

Connect your 4.3-inch/7-inch TFT-LCD to the TFT-LCD interface.

**3) Connect Ethernet cable**

Connect the Ethernet cable to the position 3 as shown in above Figure 2-1.

**4) Connect the 5V power adapter to the evaluation board**



## 2.2 Software Setup

### 2.2.1 Windows XP Setup

#### 1) Setup Linux boot tool

Install Linux boot tool [AISgen\_d800k006\_Install\_v1.7.exe], location on CD: CDROMLinux\tools\, select the default configuration to install.

#### 2) Setup WinCE component

Install WinCE boot tool [dotNetFx40\_Full\_x86\_x64.exe], location on CD: CDROMWINCE600\tools\, select the default configuration to install.

#### 3) Setup a HyperTerminal on PC

Before SBC8018 board boot-up, you need to setup a HyperTerminal connection on PC; follow the below steps in order to setup a Hyper Terminal connection:

- a) Windows XP -> Start -> All Programs -> Accessories -> Communication -> Hyper Terminal:

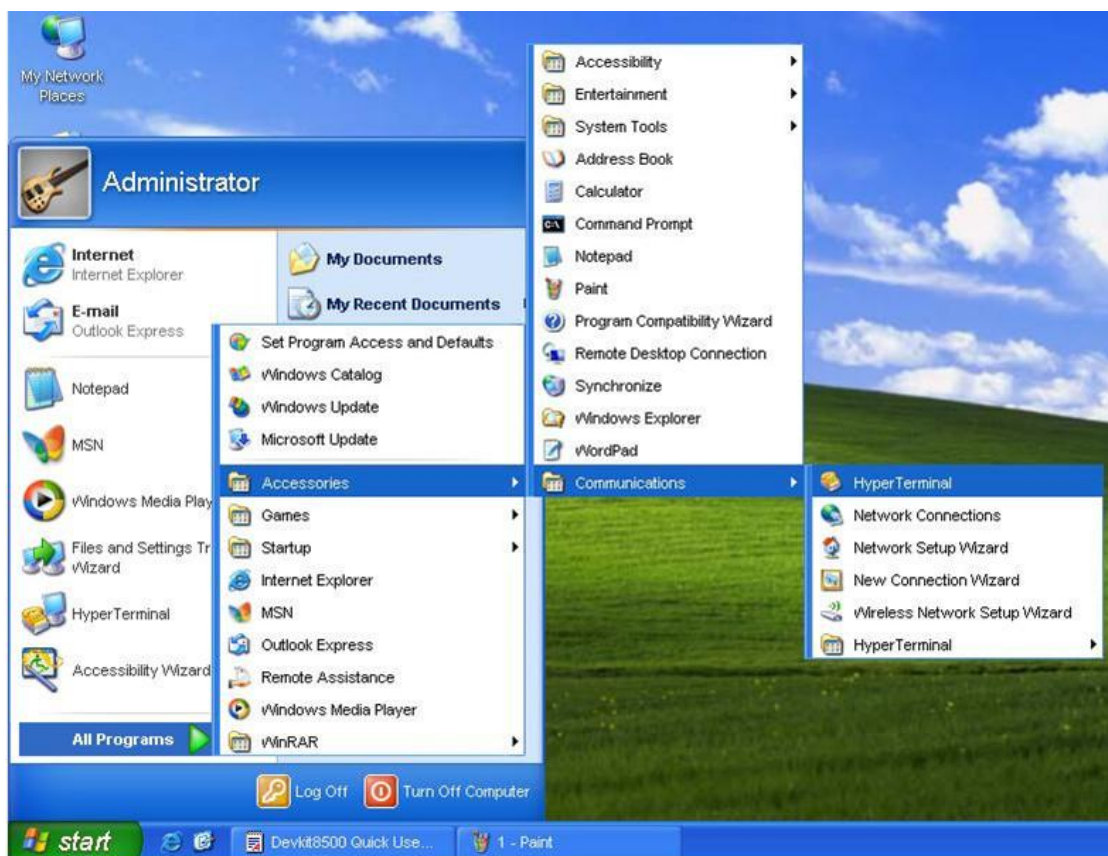

Figure 2-2

Establish HyperTerminal connection and give commands:



Figure 2-3

b) Select the specific serial port from the list as per your computer COM port configuration:



Figure 2-4

c) Set parameters for serial port connection as below:

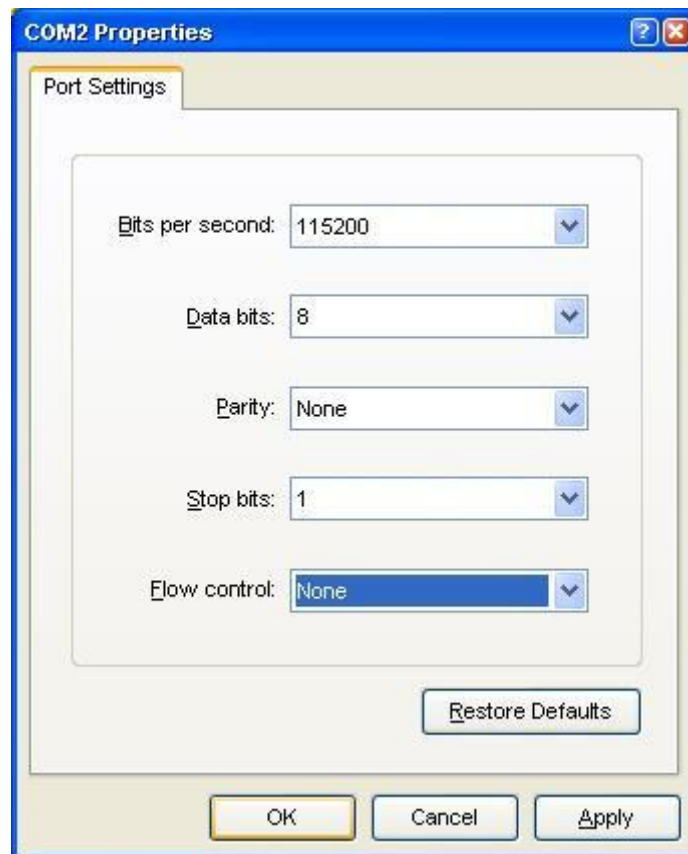

Figure 2-5

d) So we have successfully established a Hyper Terminal connection with PC serial port:

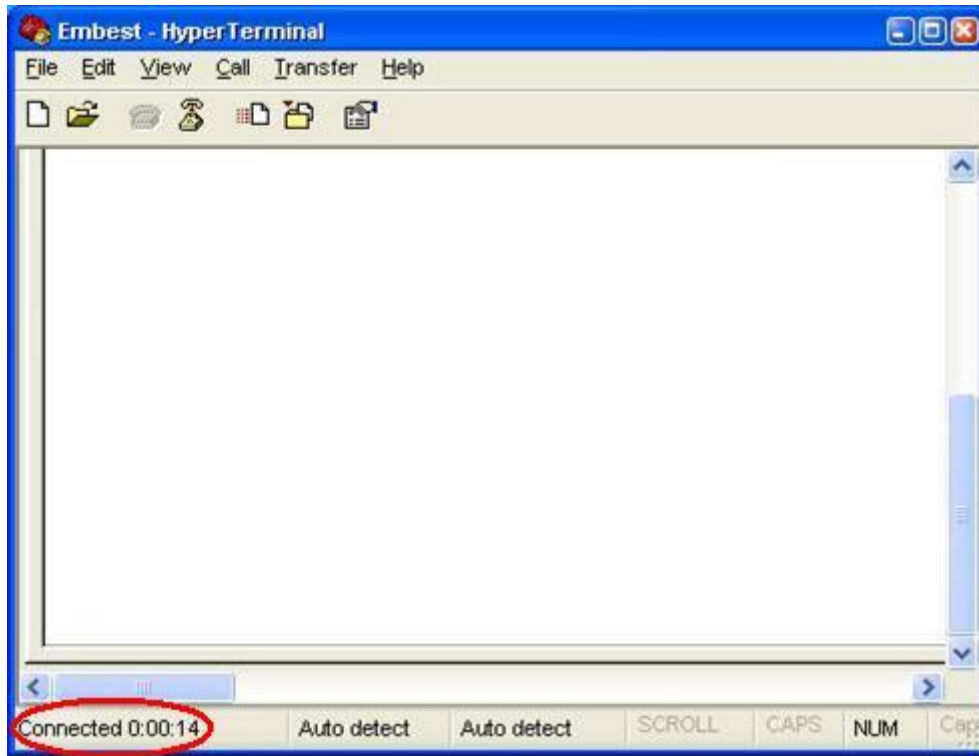

Figure 2-6

### 2.2.2 Notes for operating system image file

- Skip this step if you have purchased 4.3-inch touch screen.
- If you have purchased 7-inch touch screen, you need to reprogram the kernel image file using specified method which has been explained in section 3 “Hands-on over and Quick Use of Operating system”.

So far, we have successfully setup hardware and software for the system, the user can now turn on the power switch to start the development with SBC8018 evaluation board.

# Chapter 3 Hands-on and Quick use of Operating System

SBC8018 evaluation board supports two operating systems, **Linux 2.6.33** and **WinCE6.0**. This chapter mainly we will do hands-on over different operating systems and learn how to use OS from serial boot and NAND Flash.

## 3.1 Quick Start up with Linux system

SBC8018 evaluation board by default comes with Linux + 4.3-inch screen display installed in NAND Flash. It will boot directly without connecting TF card once it's powered on or reset, and to enter into the Linux system you just need to enter "root".

Please make sure the switch [S7] settings are selected as below:

Switch S7-1 to ON position, rest switches are on OFF position..

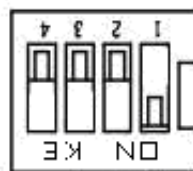

Figure 3-1 Boot-up from NAND Flash

### 3.1.1 Boot-up from Serial port

1) After the setup of hardware, make sure the switch [S7] settings are selected as below:

Switch S7-3 and S7-4 to ON position, rest switches are on OFF position.

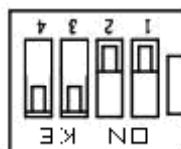

Figure 3-2 Boot-up from Serial port

2) Open the AISgen\_d800k006\_Install\_v1.7.exe:

- Windows XP -> Start -> All Programs -> Texas Instruments -> AISgen for D800K006 -> UART Boot Host

- Add u-boot-uart-ais.bin [Directory: CD\linux\image\] to the “AIS-File” as below:

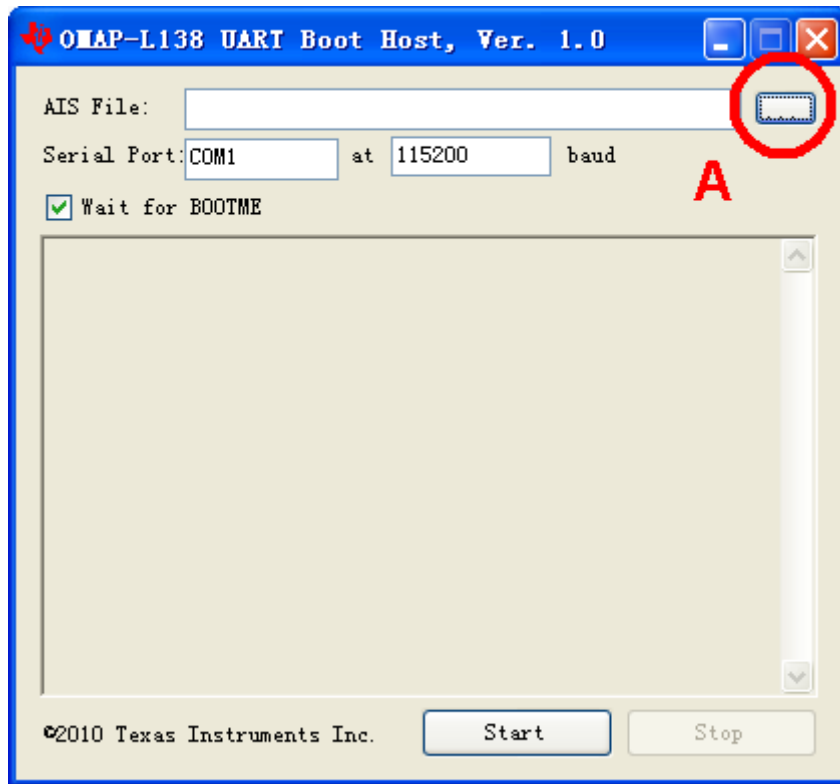

Figure 3-3

- 3) Click the “Start” and power on the evaluation board to boot-up from serial port.
- 4) Wait for moment, the target window will display “(Serial Port): Closing COM1.”, close the tool and open the Hyperterminal to catch the serial port information.



.....  
 User should open Hyperterminal and Input any key to enter U-BOOT prompts **in three seconds**, or else U-BOOT will load default parameter.  
 .....

### 3.1.2 Update images from Ethernet

SBC8018 board can update images through Ethernet, insert TF card to update images with u-boot prompts, this section manual show to update image using Ethernet.

Let’s assign the below IP’s for the PC and the evaluation board:

PC: 192.192.192.154

Evaluation board: 192.192.192.215

- 1) PC TFTP service

- a) As shown in the Figure 3-1-2-1, launch the tftpd32.exe from the CD under the folder CD\linux\tools, and click “Browse” to set the sharing space:

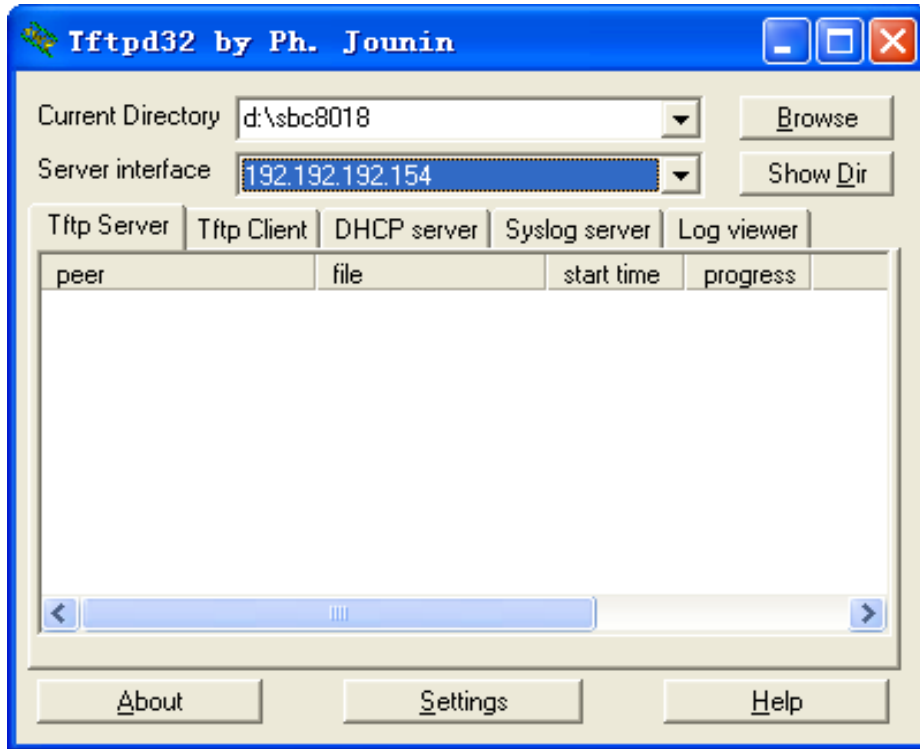

Figure 3-4 tftpd32 tool

- b) Copy u-boot-nand-ais.bin, ulmage\_4.3, ulmage\_7, jffs2.img from the CD under the folder CD\linux\image\ to the folder d:\sbc8018.
- c) According to your LCD types (4.3" or 7"), rename the ulmage\_xx as ulmage.
- 2) On U-BOOT prompts input the commands as below:
- a) Set the environment with “ipaddr” and “serverip”:

```
U-Boot > setenv ipaddr 192.192.192.215
```

```
U-Boot > setenv serverip 192.192.192.154
```

- b) Erase the NAND Flash

```
U-Boot > nand erase
```

```
NAND erase: device 0 whole chip
```

```
Skipping bad block at 0x0ff80000
```

```
Skipping bad block at 0x0ffa0000
```

```
Skipping bad block at 0x0ffc0000
```

```
Skipping bad block at 0x0ffe0000
```



OK

c) Write U-BOOT

```
U-Boot > tftp 0xc0700000 u-boot-nand-ais.bin;nand write.i 0xc0700000 0x20000
$(filesize)
Using device
TFTP from server 192.192.192.154; our IP address is 192.192.192.215
Filename 'u-boot-nand-ais.bin'.
Load address: 0xc0700000
Loading: #####
done
Bytes transferred = 210860 (337ac hex)
NAND write: device 0 offset 0x20000, size 0x337ac
210944 bytes written: OK
U-Boot > nandecc sw
SW ECC selected
```

d) Write kernel

```
U-Boot > tftp 0xc0700000 ulmage;nand write.i 0xc0700000 0x200000 $(filesize)
Using device
TFTP from server 192.192.192.154; our IP address is 192.192.192.215
Filename 'ulmage'.
Load address: 0xc0700000
Loading: #####
#####
#####
done
Bytes transferred = 2299460 (231644 hex)
NAND write: device 0 offset 0x200000, size 0x231644
2299904 bytes written: OK
```

e) Write file system

```

U-Boot > tftp 0xc2000000 jffs2.img;nand write.i 0xc2000000 0x600000 ${filesize}

Using device

TFTP from server 192.192.192.154; our IP address is 192.192.192.215

Filename 'jffs2.img'.

Load address: 0xc2000000

Loading: #####
          #####T
#####
          #####
          #####T          #T
#####
          #####

done

Bytes transferred = 3889116 (3b57dc hex)

NAND write: device 0 offset 0x600000, size 0x3b57dc

3889152 bytes written: OK
    
```

3) NAND Flash boot-up

Please make sure the switch [S7] settings are selected as below:

Switch S7-1 to ON position, the rest switches should be in OFF position.

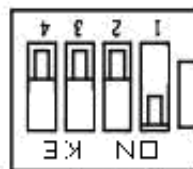

Figure 3-5 Boot-up from NAND Flash

## 3.2 Quick Start up with WinCE system

### 3.2.1 Flashing EBOOT to NAND Flash

EBOOT can be downloaded to NAND Flash using sfh\_OMAP-L138.exe (to run this you need .net framework, please install dotNetFx40\_Full\_x86\_x64.exe from Microsoft).

- 1) Make sure the connection established using serial cable between evaluation board and PC.
- 2) Switch S7-3 and S7-4 to ON position, rest switches should be to OFF position.

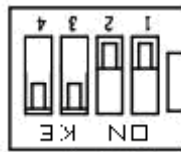

Figure 3-6 Boot-up from Serial port

- 3) Copy the folder "bin" from the CD (folder CD\WINCE600\tools) to the folder D:\sbc8018.
- 4) Depending on your LCD size, copy the EBOOTNANDFLASH.nb0 from the CD (folder WINCE600\Image\4\_3INCH or WINCE600\image\7INCH) to the folder D:\sbc8018\bin.
- 5) Click Start -> All Programs -> run, and input "CMD" command on the pop-up dialog to enter into the Windows Command Prompt(cmd.exe), after that enter the following commands as below:

```
d:
cd \sbc8018
```

- 6) Run the flash tool to erase the NAND Flash: (change COM port if required)

```
sfh_OMAP-L138.exe -erase -targetType AM1808 -flashType NAND -p COM1
```

- 7) Now power ON the Kit, you should see the Erase sequence starts and the progress will be displayed on the screen, wait until it completes, and then power OFF the kit.

*Note: If the erase sequence does not complete after 30 seconds press a key to terminate the sfh\_OMAP-L138.exe program and continue with the flashing procedure.*

- 8) Run the flash tool to write an appropriate UBL (First Bootloader) and EBOOT to flash (change COM port if required).

```
sfh_OMAP-L138.exe -flash -targetType AM1808 -flashType NAND -v -p COM1
-appStartAddr 0xc7f60000 -appLoadAddr 0xc7f60000 arm-nand-ais-456mhz.bin
```

## EBOOTNANDFLASH.nb0

- Power ON the Kit, you should see the write sequence starts and the progress will be displayed on the screen, wait until it completes.

```
Flashing UBL arm-nand-ais-456mhz.bin (13776 bytes) at 0x00000000
Target: SENDIMG
Target: BEGIN
100% | ██████████
Image data transmitted over UART.
Target: DONE
100% | ██████████
UBL programming complete
Target: SENDIMG
Target: DONE

Flashing application EBOOTNANDFLASH.nb0 (262144 bytes) at 0x00010000
Target: SENDIMG
Target: BEGIN
100% | ██████████
Image data transmitted over UART.
Target: DONE
100% | ██████████
Application programming complete

Target: Number of blocks needed for header and data: 0x0x00000003
Target: Attempting to start in block number 0x0x00000006.
Target: Magicnum: 0x0x55424CBB
Target: Entrypoint: 0x0xC7F60000
Target: Numpage: 0x0x00000000
Target: Writing header and image data to Block 0x00000006, Page 0x000000
00
Target: DONE
Target: DONE

Operation completed successfully.
```

Figure 3-7

- Power OFF the Kit and set DIP switches S7-1 to ON, all others to OFF.

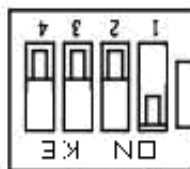

Figure 3-8

- Start the serial terminal application (115200 baud, 8N1)
- Power ON the Kit and you will see that the board will boot with the new EBOOT image.

### 3.2.2 How to update TF Card NK runtime images

#### 1) Format TF card

Format the TF Card in FAT/FAT32 file system.

#### 2) Copy NK runtime image

- a) Navigate to the directory WINCE600/image/lcd7inch or WINCE600/image/lcd4.3inch, depending on your LCD size.
- b) Copy NK.nb0/NK.bin to TF card.

#### 3) Change the EBOOT settings to boot NK from TF Card

Insert the TF card to the kit slot, power ON the kit and press the space button to enter to the EBOOT menu.

- a) Press the key [2] -> [2] -> [2] in steps to select boot "NK from TF card"

```

Booting with TI UBL
Device OPP (456MHz, 1.3V)01
Microsoft Windows CE Bootloader Common Library Version 1.4 Built Sep 23 2011 15:29:43
INFO:OALLogSetZones: dpCurSettings.ulZoneMask: 0xb
Microsoft Windows CE EBOOT 1.0 for AM1808 OMAPL138/AM18X EVM. Built Sep 23 2011 at
15:30:38

BSP version 1.3.0, SOC version 1.3.0
CODE : 0xC7F60000 -> 0xC7FA0000
DATA : 0xC7FA0000 -> 0xC7FE0000
STACK : 0xC7FE0000 -> 0xC8000000

Enabled OAL Log Zones : ERROR, WARN, INFO,
Platform Init done
System ready!
Preparing for download...
Predownload...
FMD: ReadID (Mfg=0x2c, Dev=0xda)
WARN: Invalid boot configuration found (using defaults)
    
```

Lan MAC: 00:08:ee:00:00:00

INFO: MAC address: 00:08:ee:00:00:00

WARN: Invalid BSP\_ARGS data found (using defaults)

WARN: Unable to get hardware entropy

Hit space to enter configuration menu **2**

-----  
 Main Menu  
 -----

- [1] Show Current Settings
- [2] Boot Settings
- [3] Network Settings
- [5] Video Settings
- [6] Save Settings
- [7] Peripheral Tests
- [R] Reset Settings To Default Values
- [0] Exit and Continue

Selection: **2**

-----  
 Boot Settings  
 -----

- [1] Show Current Settings
- [2] Select Boot Device
- [3] Select Boot Delay
- [4] Select Debug Device
- [5] Force Clean Boot

- [6] Write Download RAM NK to Flash
- [7] Set Device ID String
- [8] Allow DSP to Boot
- [0] Exit and Continue

Selection: **2**

-----  
 Select Boot Device  
 -----

- [1] EMAC
- [2] NK from SD
- [3] NK from NAND flash
- [0] Exit and Continue

Selection (actual NK from SD): **2**

Boot device set to NK from SD

- b) Press the key [0] -> [0] by step to start system boot from SD card, and you would see the following serial port information on Hyper terminal:

-----  
 Boot Settings  
 -----

- [1] Show Current Settings
- [2] Select Boot Device
- [3] Select Boot Delay
- [4] Select Debug Device
- [5] Force Clean Boot
- [6] Write Download RAM NK to Flash
- [7] Set Device ID String

[8] Allow DSP to Boot

[0] Exit and Continue

Selection: **0**

-----  
Main Menu  
-----

[1] Show Current Settings

[2] Boot Settings

[3] Network Settings

[5] Video Settings

[6] Save Settings

[7] Peripheral Tests

[R] Reset Settings To Default Values

[0] Exit and Continue

Selection: **0**

Device ID set to AM1808-0

BLFlashDownload: LogicalLoc - 0x01C40000

Loading from SD card

+ReadNKFromSDMMC

ReadFileFromSDMMC: reading file 'nk.bin'

SDBootPDD: PDD\_SDInitializeHardware: MMCSD

SDBootMDD: SDInitializeHardware: SD card detected

SDBootMDD: SDInitializeHardware: V2.0 card detected

SDBootMDD: SDInitializeHardware: timeOut = 0

SDBootMDD: SDInitializeHardware: timeOut = 1

SDBootMDD: SDInitializeHardware: timeOut = 2



```

SDBootMDD: SDInitializeHardware: timeOut = 3
SDBootMDD: Card address is 1234
SDBootMDD: 4-bit data bus selected
InitMasterBootRecord: Partition 0, type 12
InitMasterBootRecord: Partition 0, FAT32, start 0x7e00, length 0x753f8200
InitPartition: Offset 0x7e00, length 0x753f8200
ReadFileFromSDMMC: file size = 16138467 bytes
UnpackBINImage: unpacking binary from 0xc2000000
UnpackBINImage: Image start = 0x80000000
UnpackBINImage: Image length = 0x102fd2c
UnpackBINImage: record 0, start=0x80000000, length=0x4, checksum=0x1eb
.....
UnpackBINImage: record 296, start=0x0, length=0x80001000, checksum=0x0
CheckCEImage: checking image at 0xc0000000

```

ROMHDR (pTOC = 0xc102de3c) -----

```

DLL First      : 0x4001c001
DLL Last       : 0x40b5c097
Physical First  : 0x80000000
Physical Last   : 0x8102fd2c
Num Modules    :      181
RAM Start      : 0x81030000
RAM Free       : 0x8103f000
RAM End        : 0x8373f800
Num Copy Entries :      2
Copy Entries Offset : 0x804f4fd4
Prof Symbol Length : 0x00000000
Prof Symbol Offset : 0x00000000
Num Files      :      73

```

```

Kernel Flags      : 0x00000000
FileSys RAM Percent : 0x30303030
Driver Glob Start  : 0x00000000
Driver Glob Length : 0x00000000
CPU               :    0x01c2
MiscFlags         :    0x0002
Extensions        : 0x80001070
Tracking Mem Start : 0x00000000
Tracking Mem Length : 0x00000000

```

-----

```

Image Start .....: 0x00000000
Image Size .....: 0x00000000
Image Launch Addr .: 0x00000000
Image ROMHDR .....: 0x00000000
Boot Device/Type ..: 3 / 6
ADEhellounch Windows Embedded CE by jumping to 0xc0000000...
Windows CE Kernel for ARM (Thumb Enabled) Built on Oct 20 2009 at 18:39:19
OEMInit: init.c built on Sep 28 2011 at 15:51:27.
BSP version 1.3.0, SOC version 1.3.0
INFO:OALLogSetZones: dpCurSettings.ulZoneMask: 0xf
WARN: Updating local copy of BSP_ARGS
Intr Init done...
Timer Init done...
+OALDumpClocks
Clock Configuration :
  Reference Clock 0 .. 24000000 Hz
  PLL0 ..... 456000000 Hz
  PLL0:SYSCLK1 ..... 456000000 Hz (DSP Subsystem)

```

```

PLL0:SYSCLK2 ..... 228000000 Hz
(UART,EDMA,SPI,MMC/SD,VPIF,LCDC,SATA,uPP,USB2.0,HPI,PRU)
PLL0:SYSCLK3 ..... 91200000 Hz (EMIFA)
PLL0:SYSCLK4 ..... 114000000 Hz (INTC, SYSCFG, GPIO, PSC, I2C1, USB1.1,
EMAC/MDIO, GPIO)
PLL0:SYSCLK5 ..... 152000000 Hz (reserved)
PLL0:SYSCLK6 ..... 456000000 Hz (ARM Subsystem)
PLL0:SYSCLK7 ..... 76000000 Hz (EMAC)
PLL0:AUXCLK ..... 24000000 Hz (I2C0, Timers, McASP0 serial clock, RTC, USB2.0
PHY)
PLL1 ..... 264000000 Hz
PLL1:SYSCLK1 ..... 264000000 Hz (DDR2/mDDR PHY)
PLL1:SYSCLK2 ..... 132000000 Hz (Optional for: McASP0,McBSP,ePWM,eCAP,SP11)
PLL1:SYSCLK3 ..... 88000000 Hz (PLL0 input)
-OALDumpClocks
-OEMInit
PINMUX14=0x00000000
PINMUX15=0x00000000
PINMUX16=0x22222200
PINMUX17=0x22222222
PINMUX18=0x22000022
PINMUX19=0x02000022
OEMGetExtensionDRAM: Added 0x84400000 -> 0x88000000
OEM: Cleaning system hive
OEM: Cleaning user profiles
WARN: Updating local copy of BSP_ARGS
OEM: Not cleaning system hive
FMD: ReadID (Mfg=0x2c, Dev=0xda)
MICBIASHardwareContext::Init 555

```

Adapter's MAC address is 00:08:EE:00:00:00

SDHC +Init

SDHC Active RegPath: Drivers\Active\21

+SDHCPDD\_Init: Ctrl 0, Entry

SDHC -Init

SDHC +Open

SDHC +Open

SDHC\_CARD\_DETECT = 1

SDHC CommandCompleteHandler: Command response timeout

SDHC CommandCompleteHandler: Command response timeout

SDHC CommandCompleteHandler: Command response timeout

SDHC CommandCompleteHandler: Command response timeout

SDHC CommandCompleteHandler: Command response timeout

SDHC CommandCompleteHandler: Command response timeout

SDHC CommandCompleteHandler: Command response timeout

SDHC CommandCompleteHandler: Command response timeout

# Customer Service & Technical support

## Customer Service

Please contact Premier Farnell local sales and customer services staffs for the help.

Website: <http://www.farnell.com/>

## Technical Support

Please contact Premier Farnell local technical support team for any technical issues through the telephone, live chat & mail, or post your questions on the below micro site, we will reply to you as soon as possible.

Centralized technical support mail box: [knode\\_tech@element14.com](mailto:knode_tech@element14.com)

Community: <http://www.element14.com/community/docs/DOC-41892>

## Notes

This board was designed by element14's design partner- Embest, you can contact them to get the technical support as well.

Marketing Department:

Tel: +86-755-25635656 / 25636285      Fax: +86-755-25616057

E-mail: [market@embedinfo.com](mailto:market@embedinfo.com)

Technical Support:

Tel: +86-755-25503401

E-mail: [support@embedinfo.com](mailto:support@embedinfo.com)      URL: <http://www.armkits.com>