

REVISIONS			
REV	DESCRIPTION	DATE	APPROVED

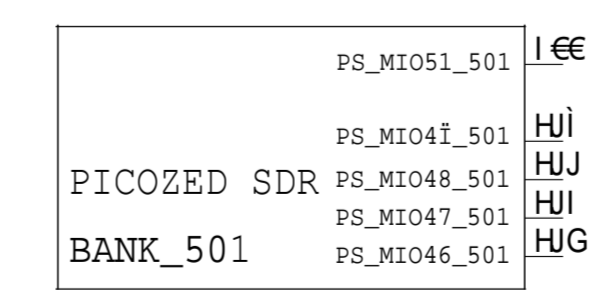
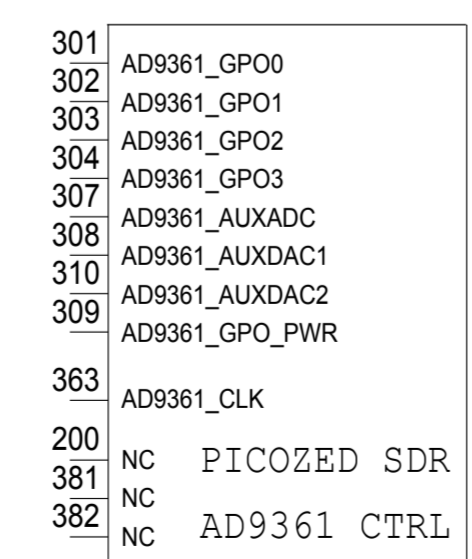
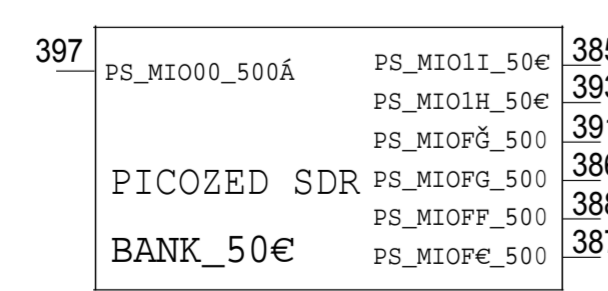
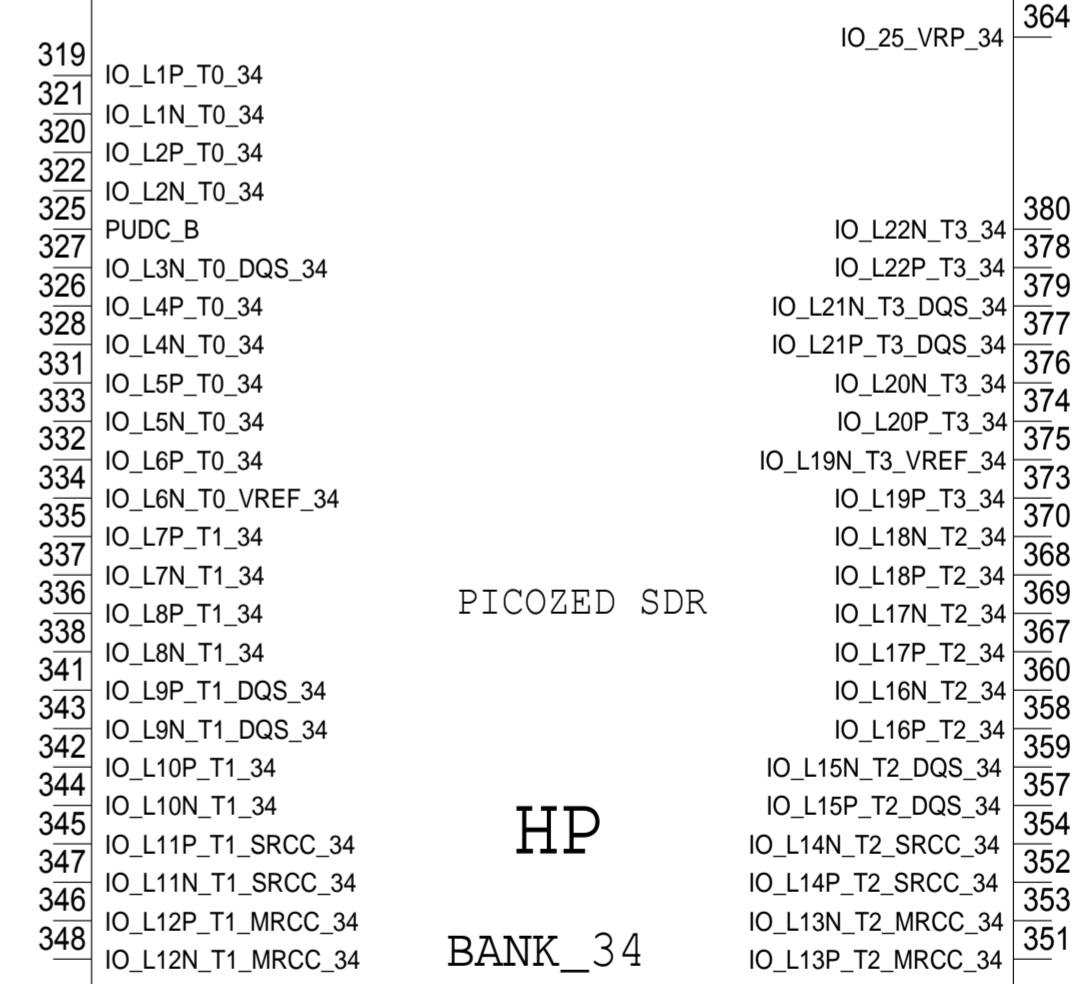
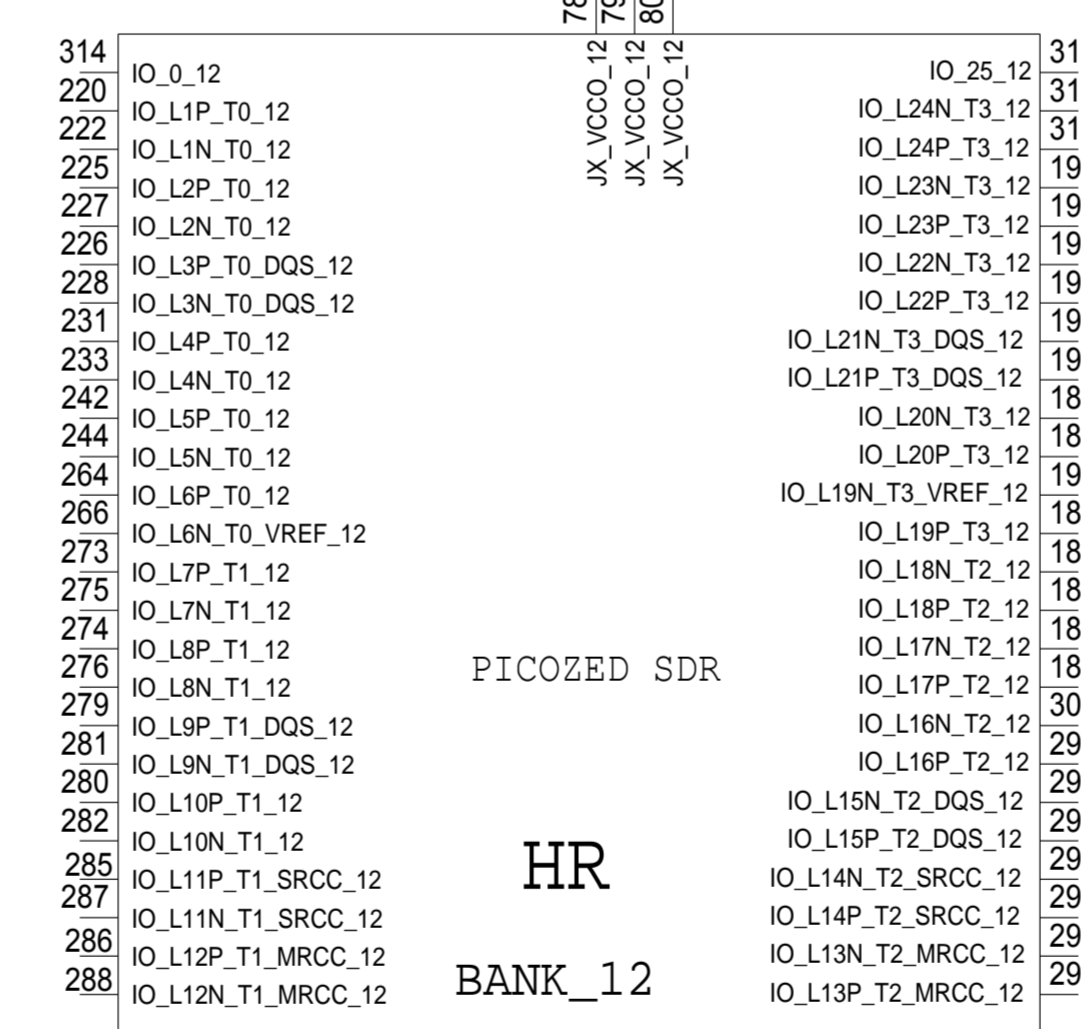
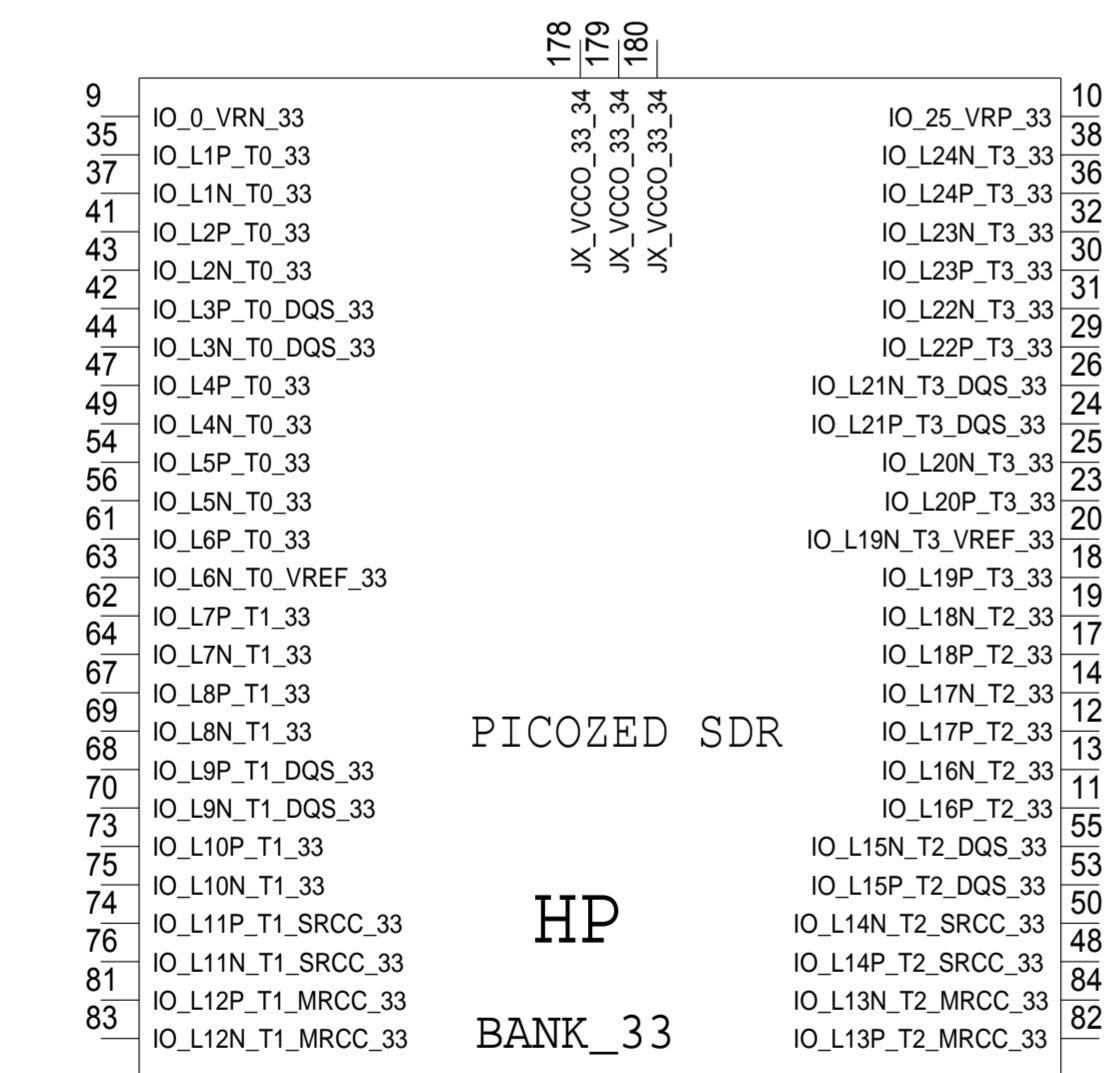
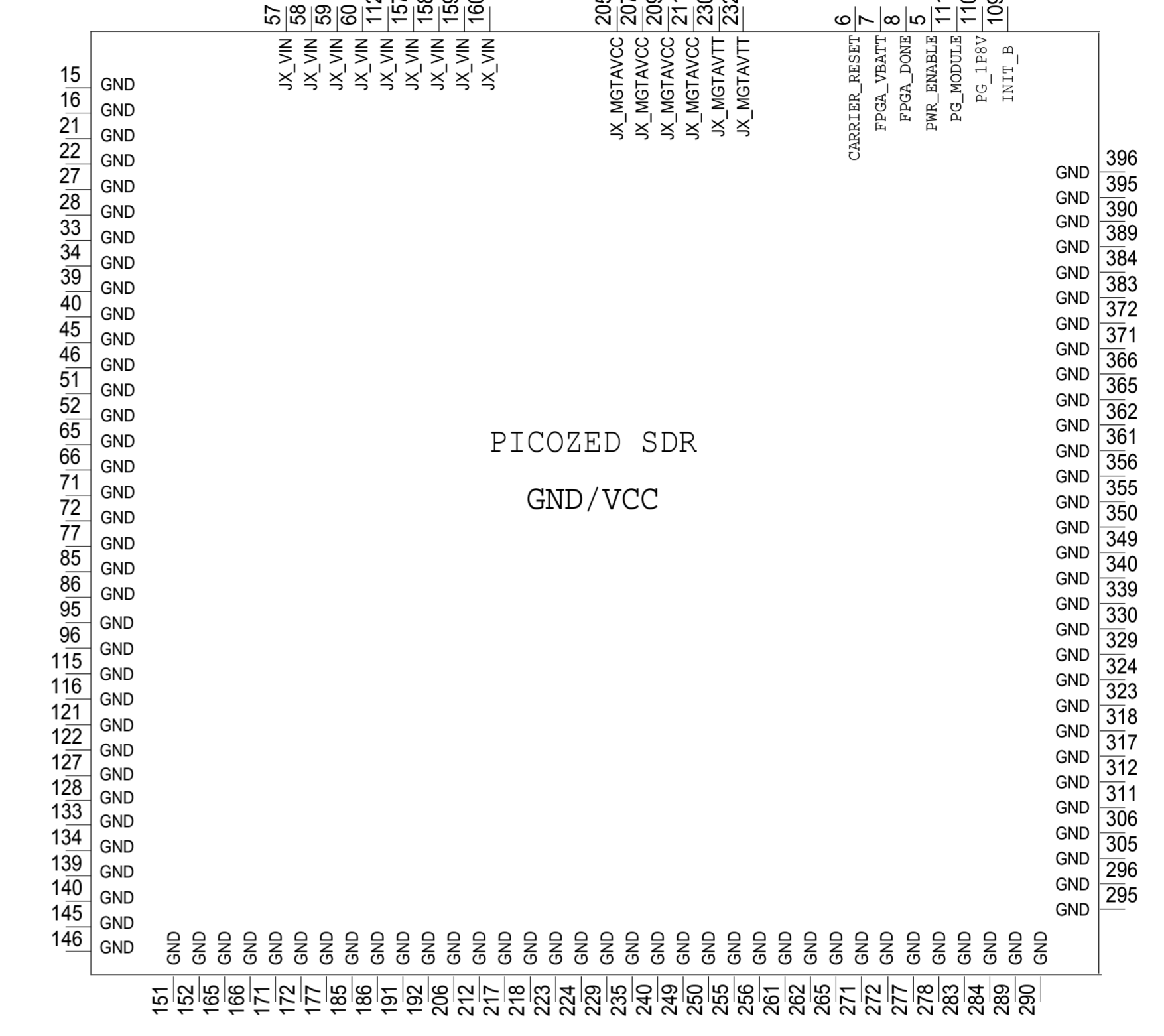
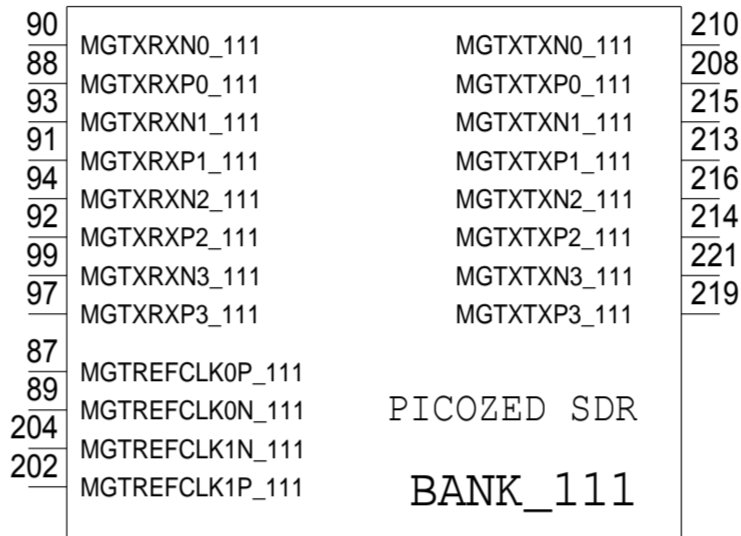
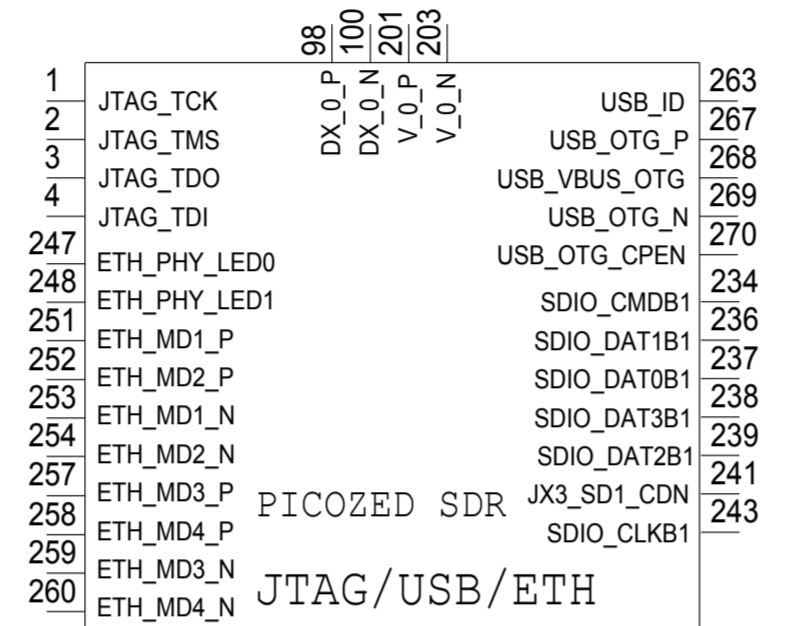
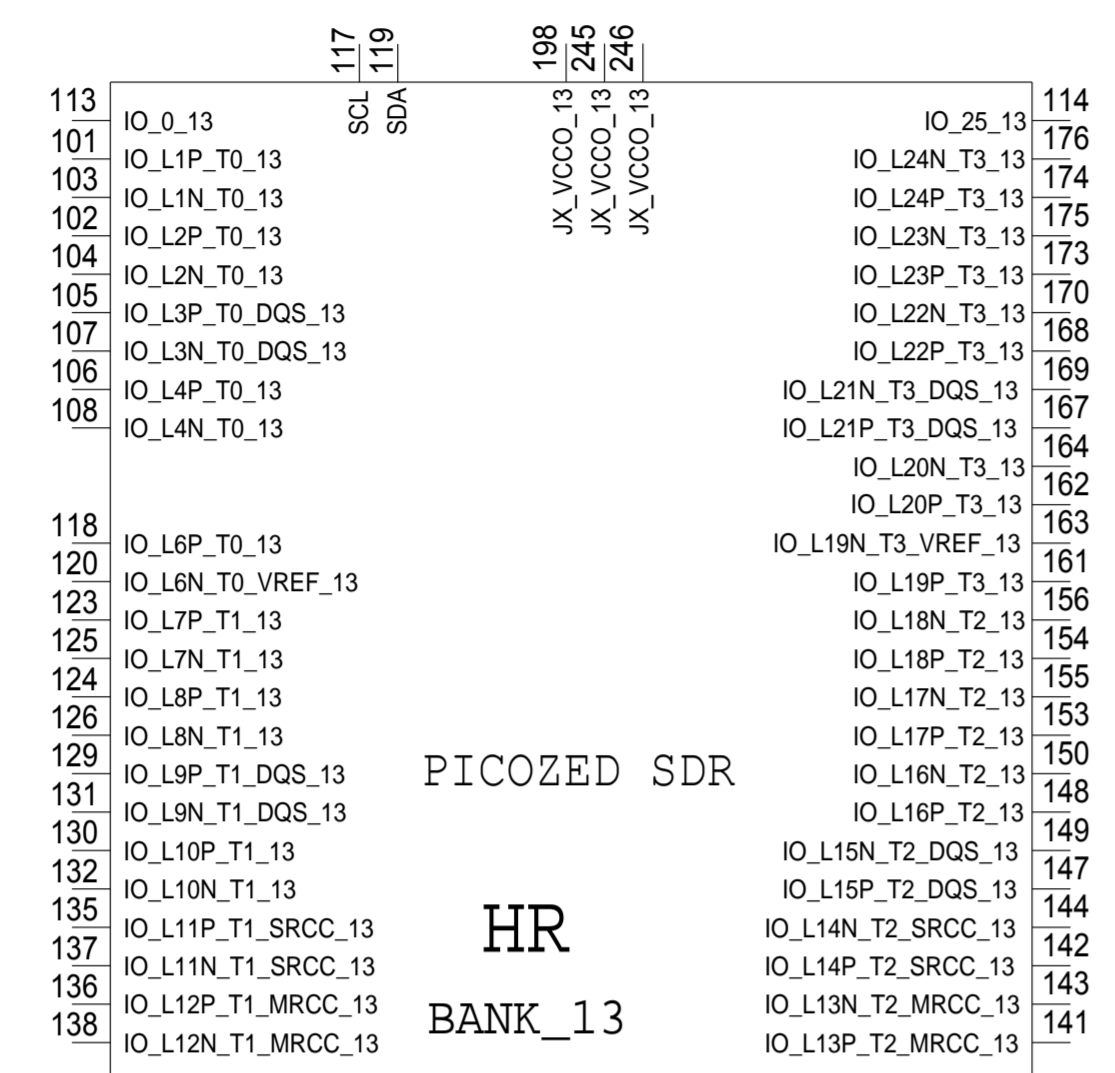

	SCHEMATIC		
	HW TYPE : PICOZED CDR CONNECTOR Product (s):		
DESIGN VIEW <DESIGN_VIEW>	DRAWING NO.		REV
PTD ENGINEER <PTD_ENGINEER>	SIZE D	SCALE 1:1	SHEET 7 OF 10

THIS DRAWING IS THE PROPERTY OF ANALOG DEVICES INC. IT IS NOT TO BE REPRODUCED OR COPIED, IN WHOLE OR IN PART, OR USED IN ANY MANNER WITHOUT THE WRITTEN PERMISSION OF ANALOG DEVICES. THE EQUIPMENT SHOWN HEREIN MAY BE PROTECTED BY PATENTS OWNED OR CONTROLLED BY ANALOG DEVICES.